

Name: _____

What is the total number of cubes for each shape?

Determine the total number of cubes and print the number beside each question.

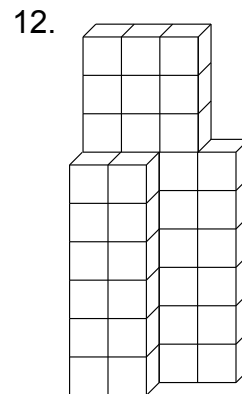

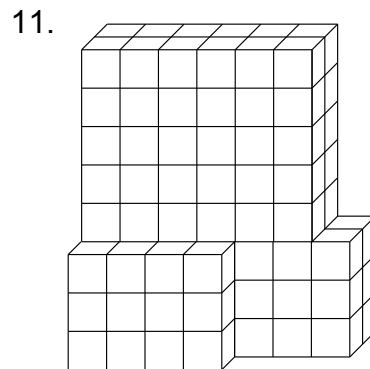
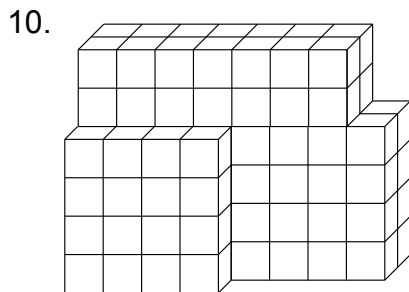
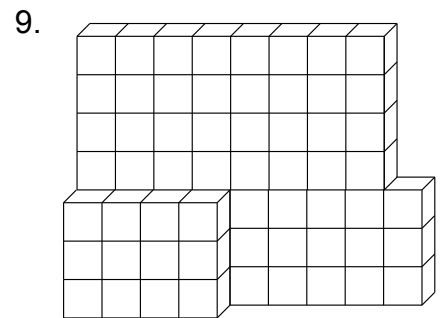
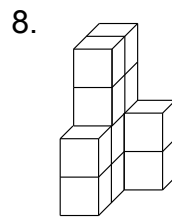
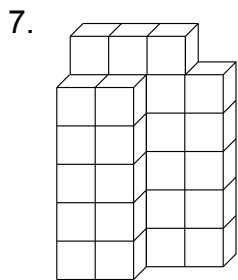
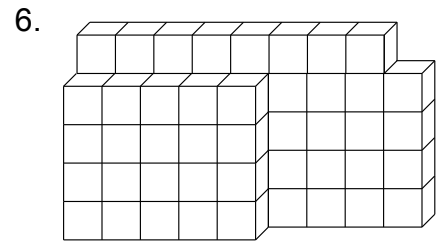
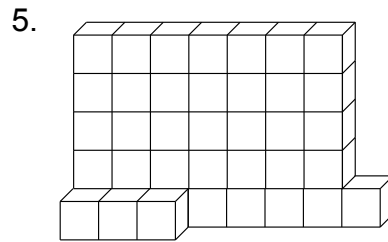
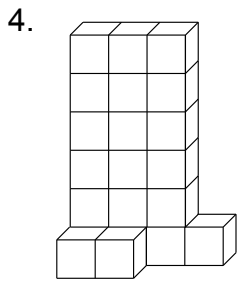
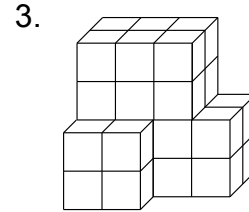
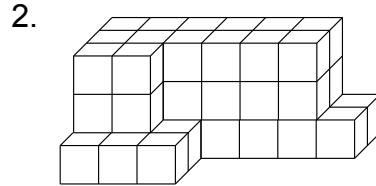
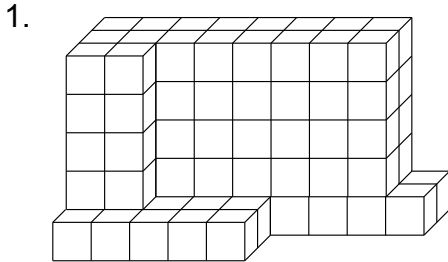
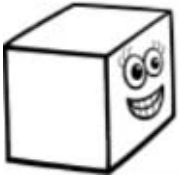

Name: _____

What is the total number of cubes for each shape?

Determine the total number of cubes and print the number beside each question.

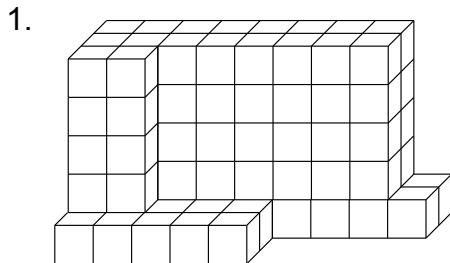

100 cubic units

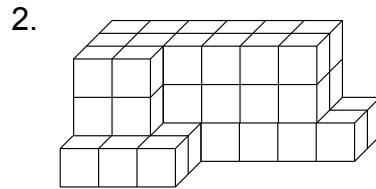

48 cubic units

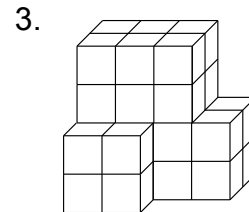

32 cubic units

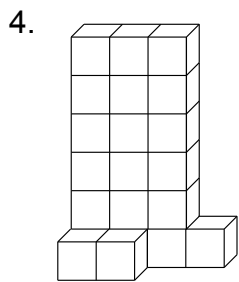

21 cubic units

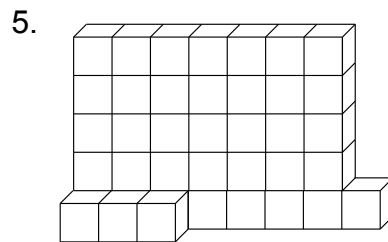

39 cubic units

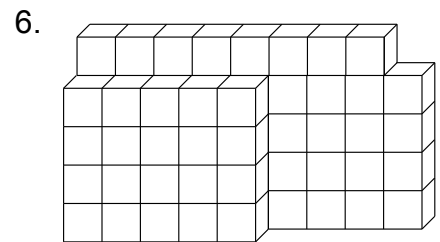

64 cubic units

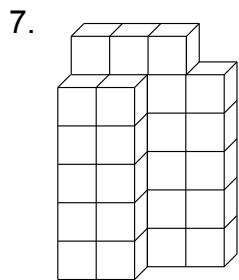

33 cubic units

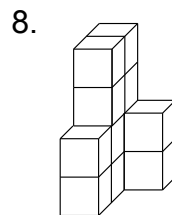

12 cubic units

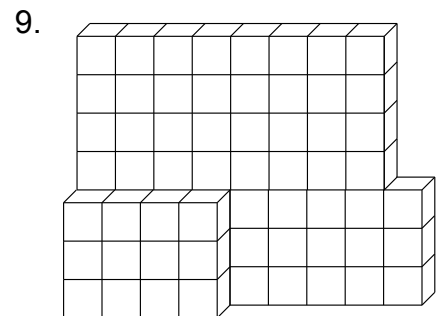

71 cubic units

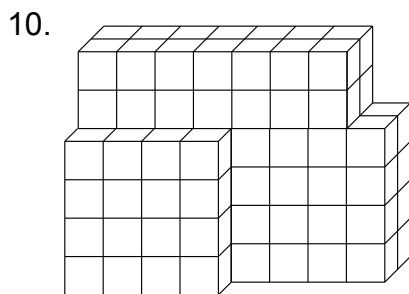

108 cubic units

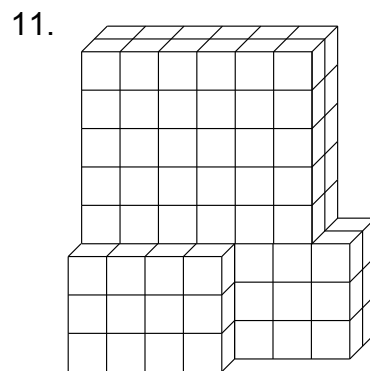

114 cubic units

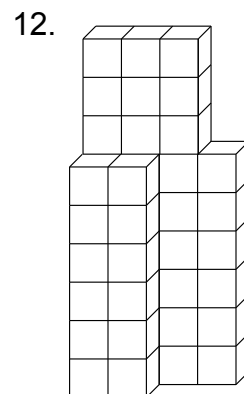

45 cubic units