

Name: _____

What is the total number of cubes for each shape?

Determine the total number of cubes and print the number beside each question.

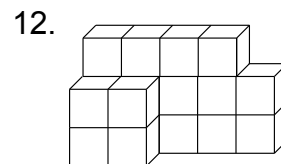

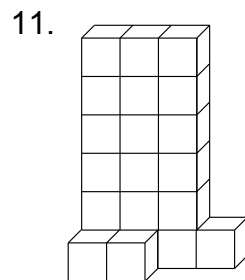
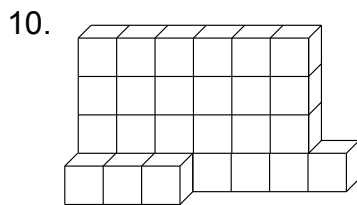
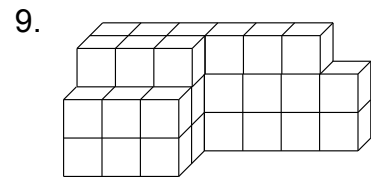
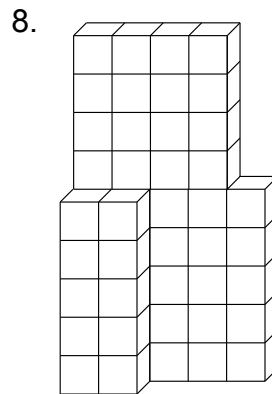
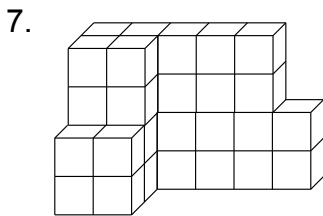
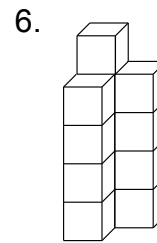
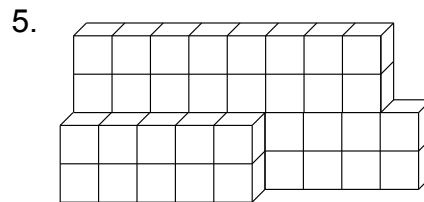
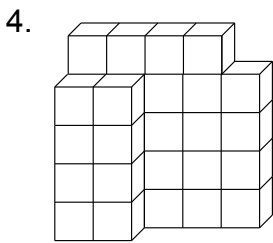
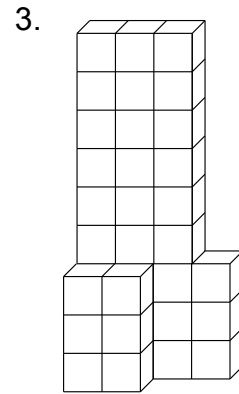
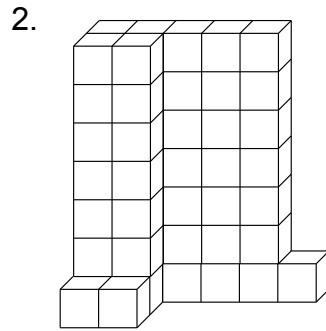
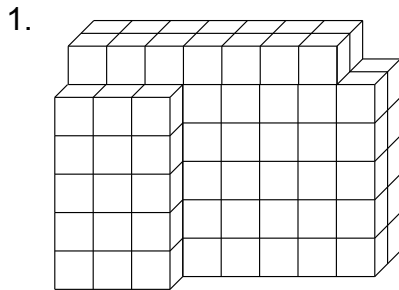
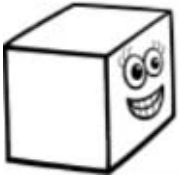

Name: _____

What is the total number of cubes for each shape?

Determine the total number of cubes and print the number beside each question.

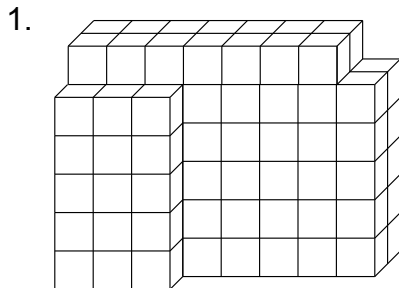

109 cubic units

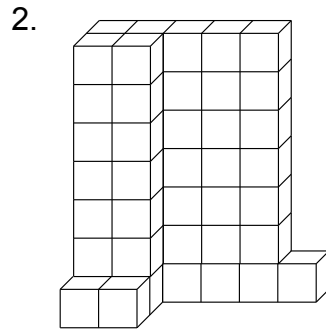

52 cubic units

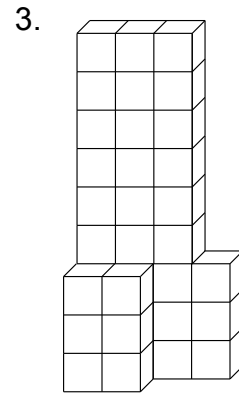

36 cubic units

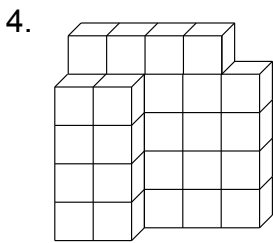

32 cubic units

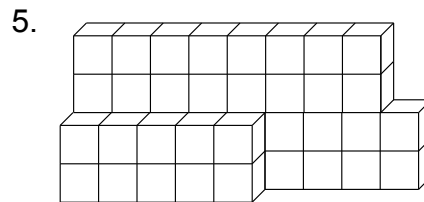

44 cubic units

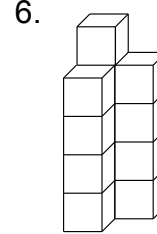

13 cubic units

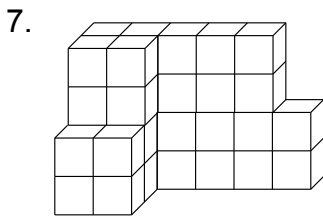

34 cubic units

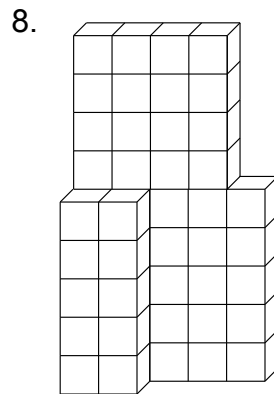

51 cubic units

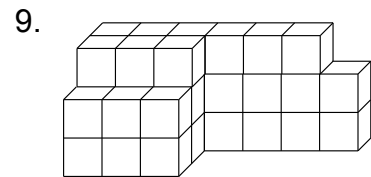

35 cubic units

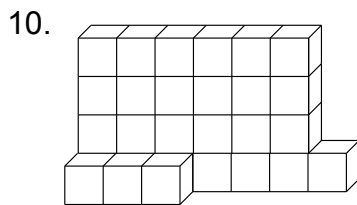

28 cubic units

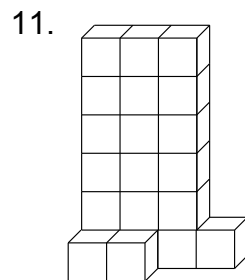

21 cubic units

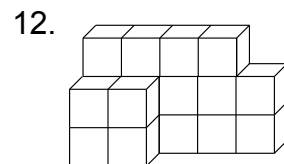

18 cubic units