

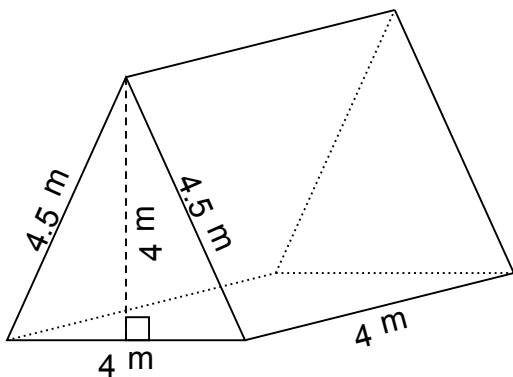

Name: _____

Calculate the Volume

1.



2.

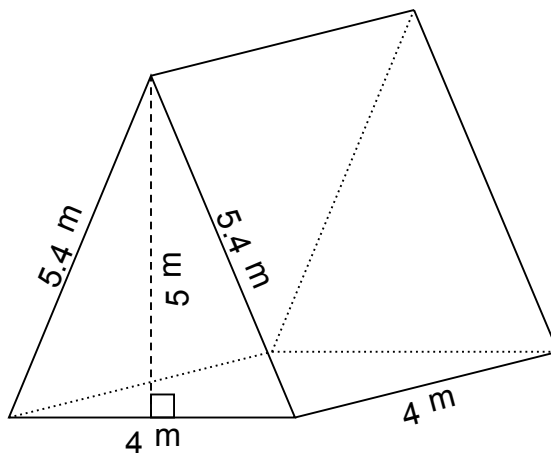

3.

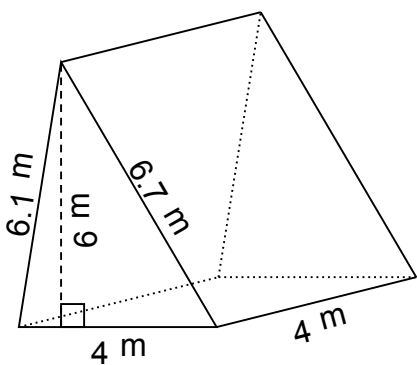

4.

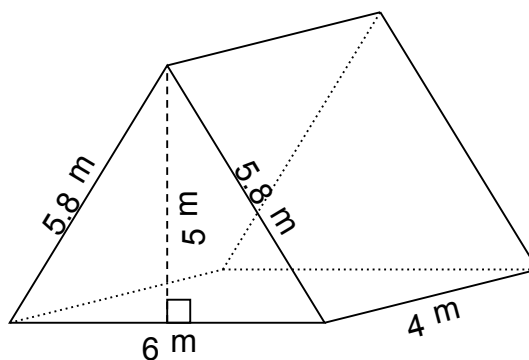

5.

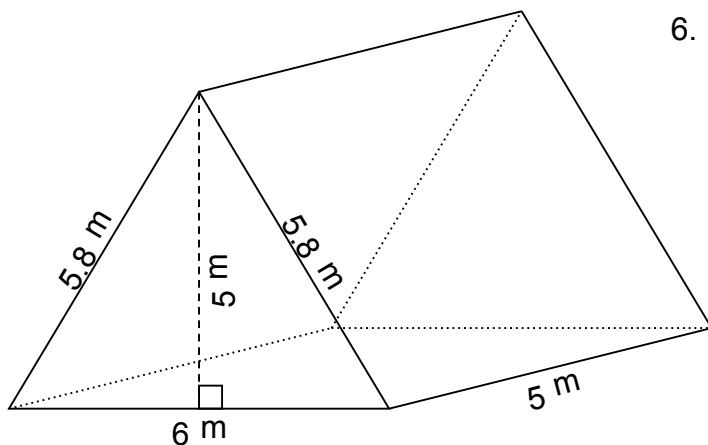

6.

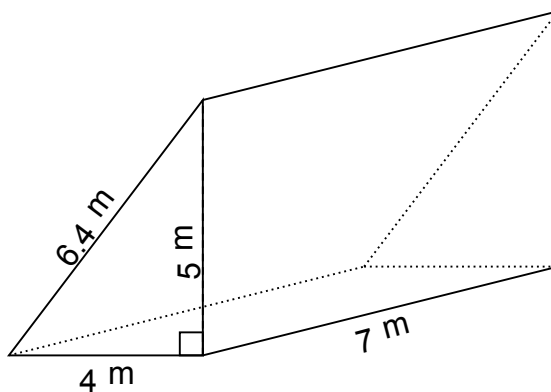



Name: _____

Calculate the Volume

1.

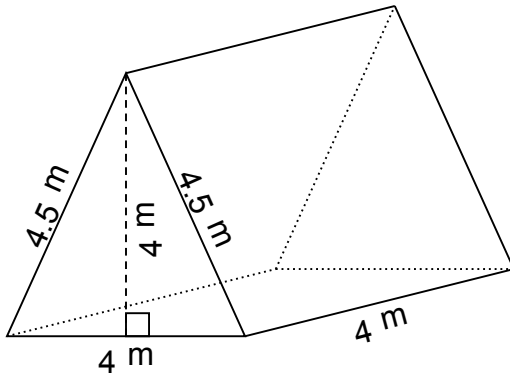

$$V = 32 \text{ m}^3$$

2.

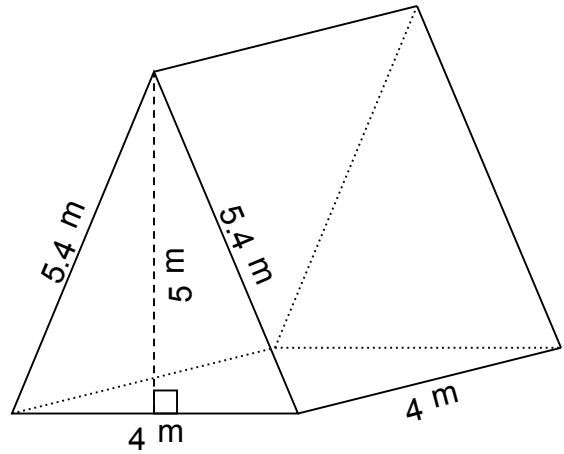

$$V = 40 \text{ m}^3$$

3.

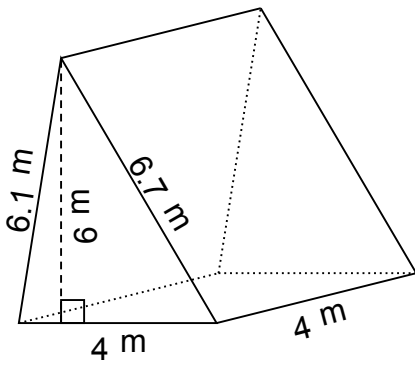

$$V = 48 \text{ m}^3$$

4.

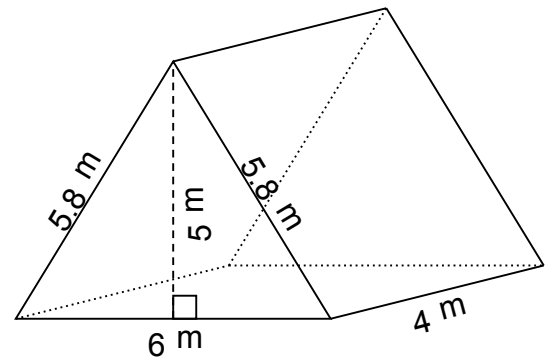

$$V = 60 \text{ m}^3$$

5.

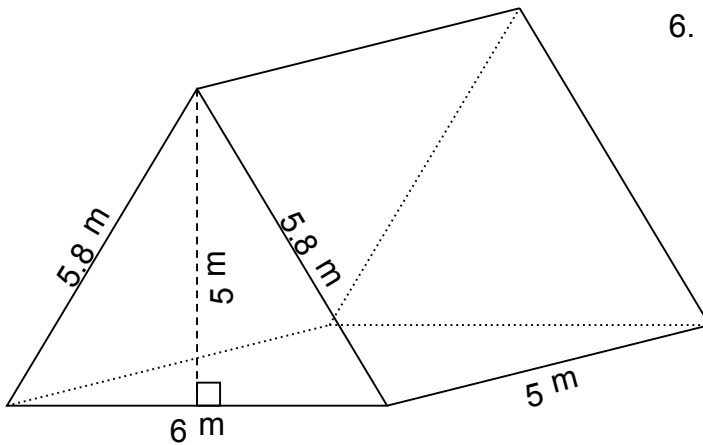

$$V = 75 \text{ m}^3$$

6.

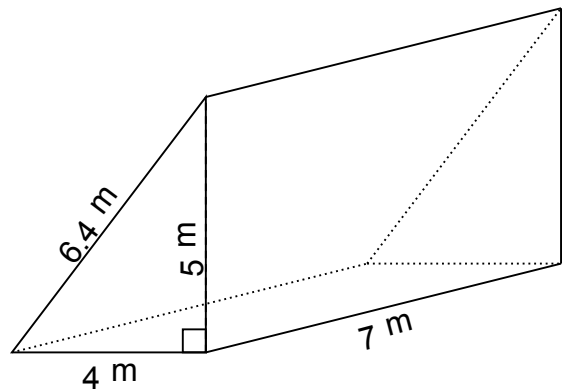

$$V = 70 \text{ m}^3$$