

Name: _____

Perimeter of Triangles

Find the perimeter of the triangles. Answer using the correct units.

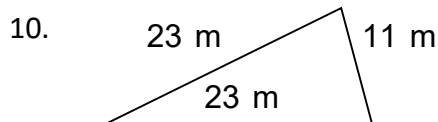

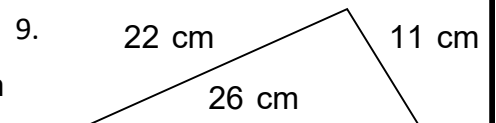
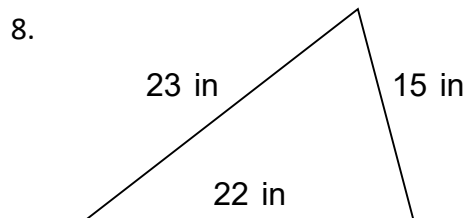
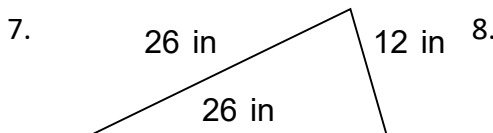
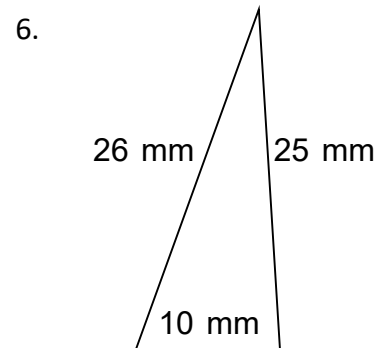
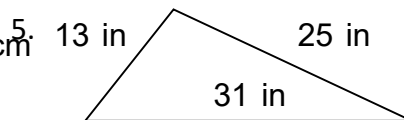
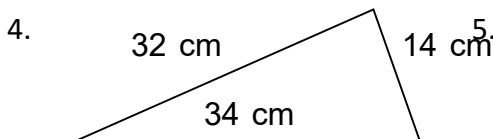
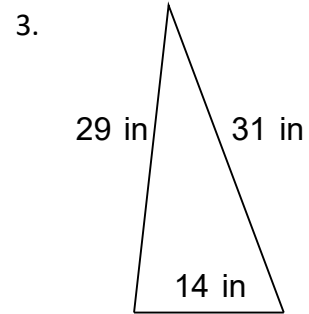
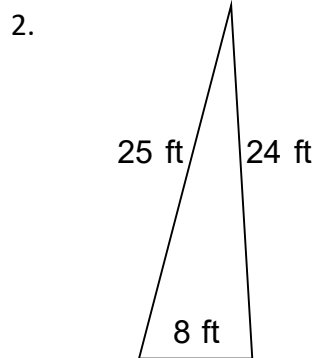
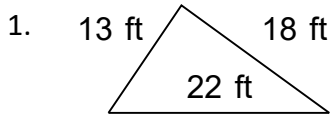
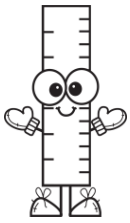

Name: _____

Perimeter of Triangles

Find the perimeter of the triangles. Answer using the correct units.

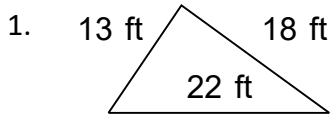

$A = 117.04 \text{ ft}^2$

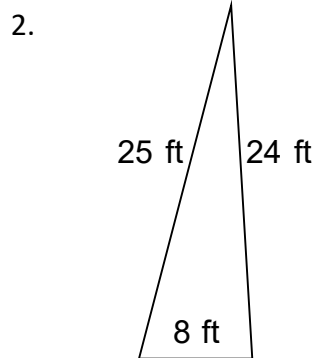

$A = 95.68 \text{ ft}^2$

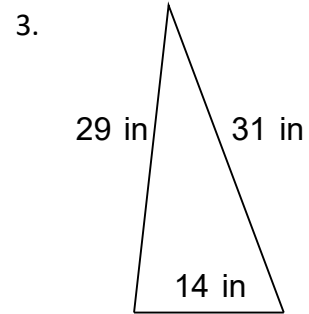

$A = 201.6 \text{ in}^2$

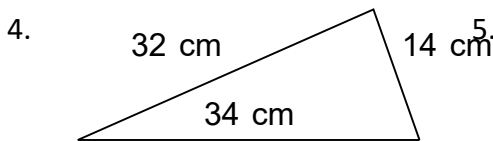

$A = 219.64 \text{ cm}^2$

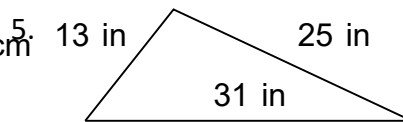

$A = 161.82 \text{ in}^2$

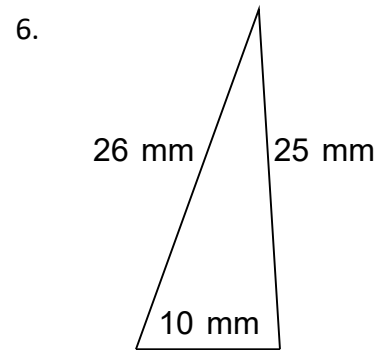

$A = 123.9 \text{ mm}^2$

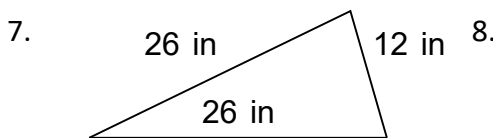

$A = 145.86 \text{ in}^2$

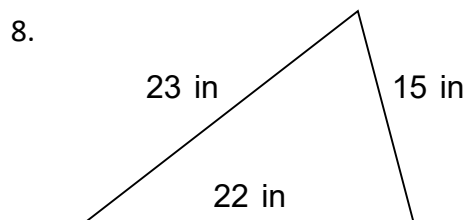

$A = 157.3 \text{ in}^2$

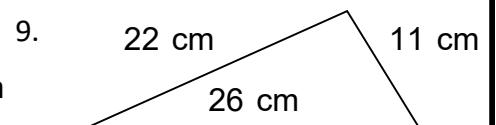

$A = 117 \text{ cm}^2$

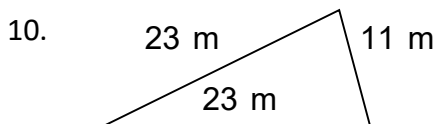

$A = 117.3 \text{ m}^2$