

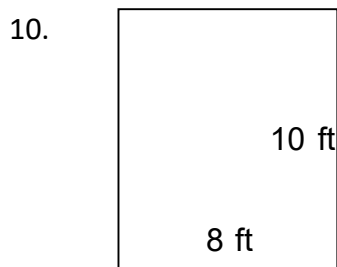

Name: _____

Perimeter of Squares and Rectangles

Find the perimeter of the squares and rectangles. Answer using the correct units.

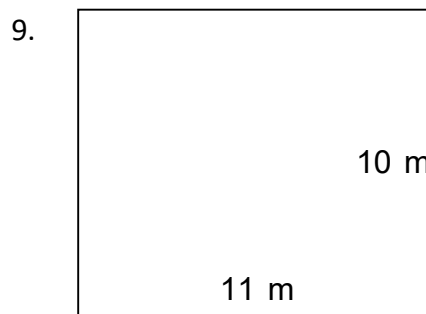
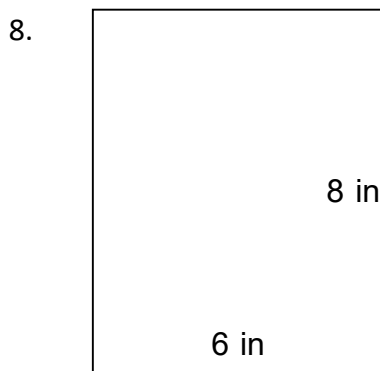
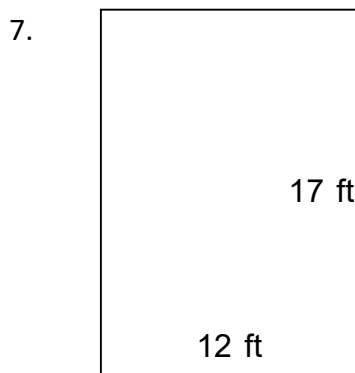
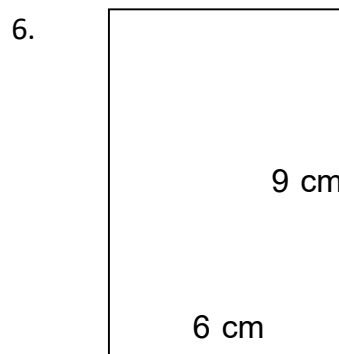
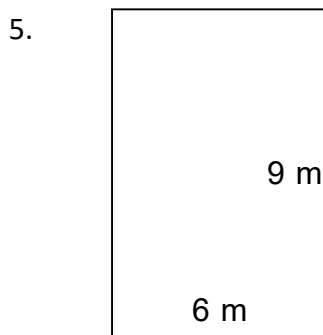
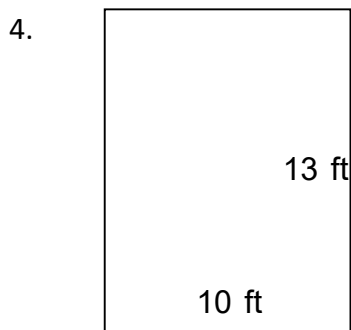
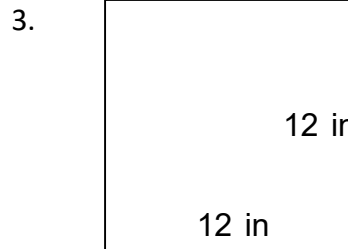
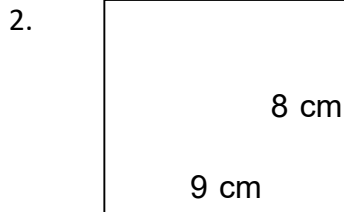
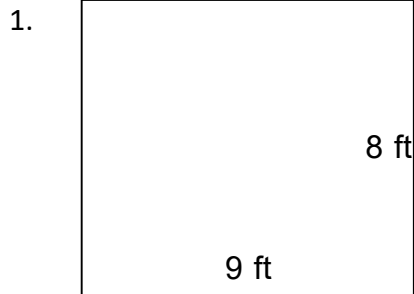



Name: _____

Perimeter of Squares and Rectangles

Find the perimeter of the squares and rectangles. Answer using the correct units.

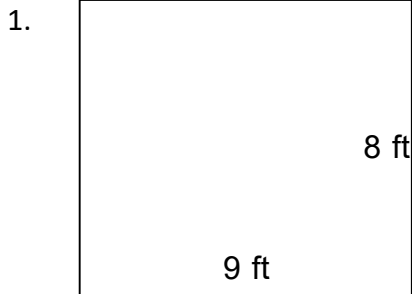

$P = 34 \text{ ft}$

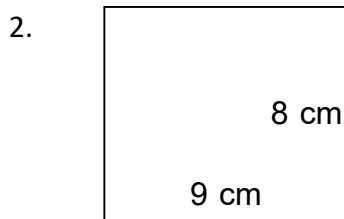

$P = 34 \text{ cm}$

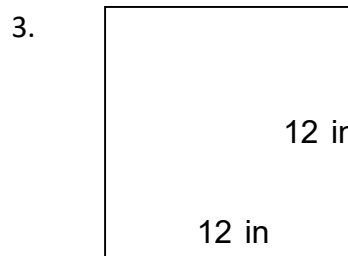

$P = 48 \text{ in}$

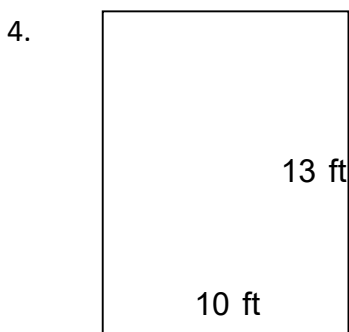

$P = 46 \text{ ft}$

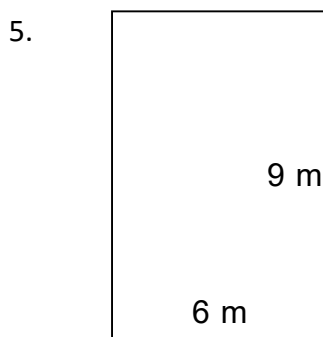

$P = 30 \text{ m}$

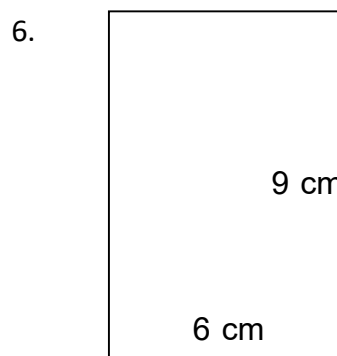

$P = 30 \text{ cm}$

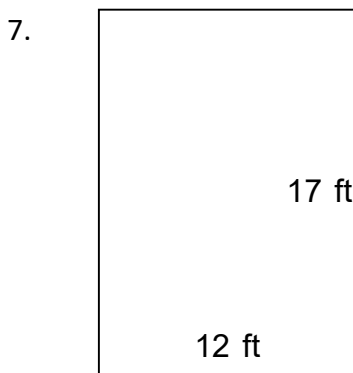

$P = 58 \text{ ft}$

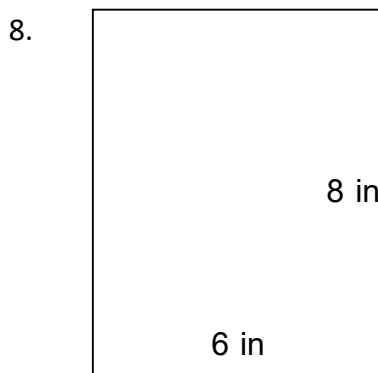

$P = 28 \text{ in}$

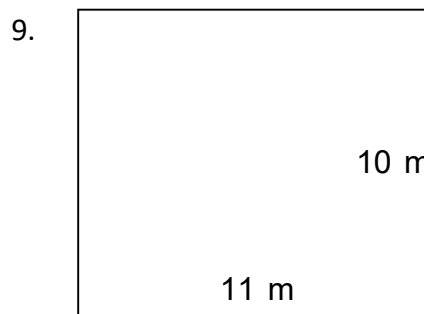

$P = 42 \text{ m}$

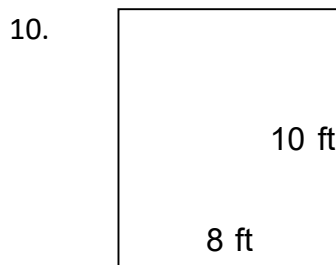

$P = 36 \text{ ft}$