

Name: _____

Find the Area of L-Shapes

Find the area of the L-Shapes. Answer using the correct units.

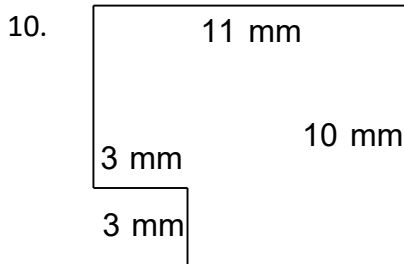

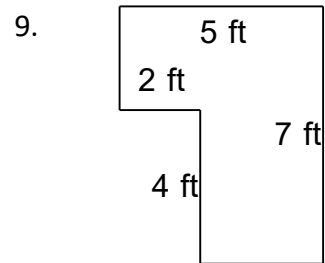
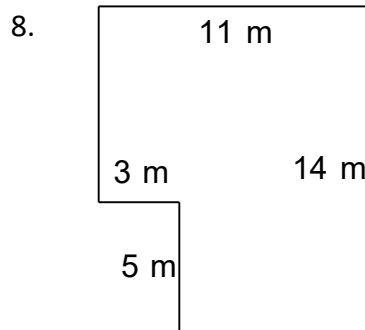
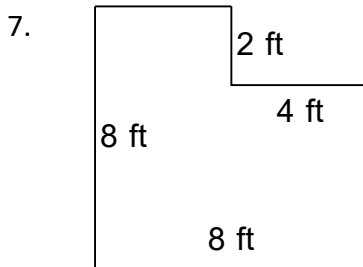
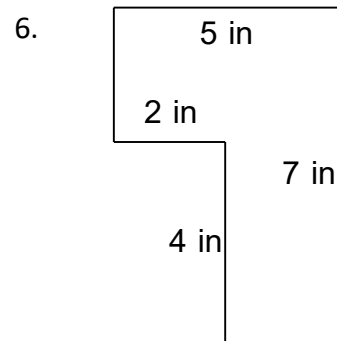
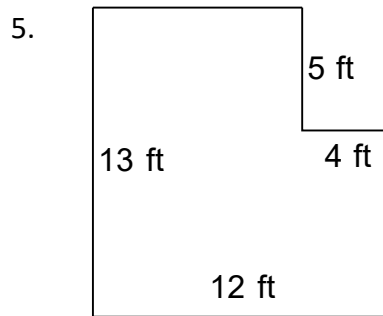
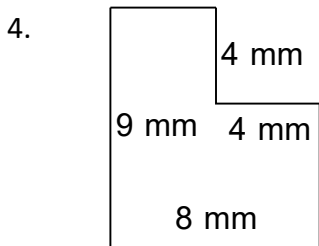
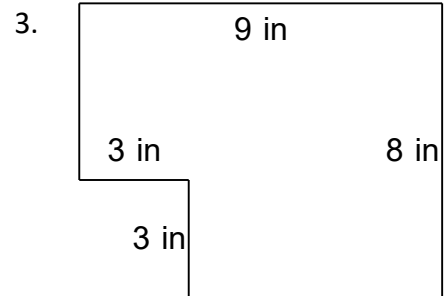
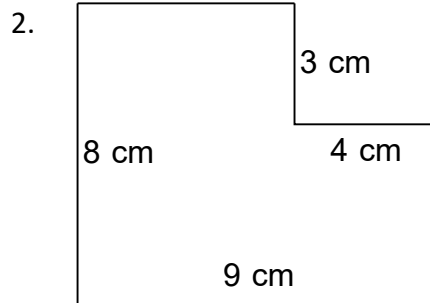
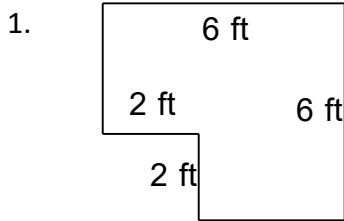
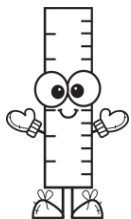

Name: _____

Find the Area of L-Shapes

Find the area of the L-Shapes. Answer using the correct units.

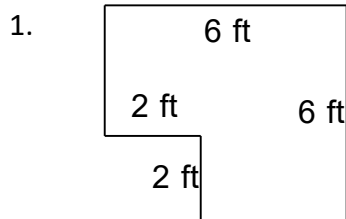

$P = 24 \text{ ft}$

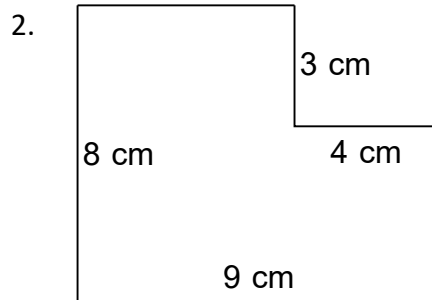

$P = 34 \text{ cm}$

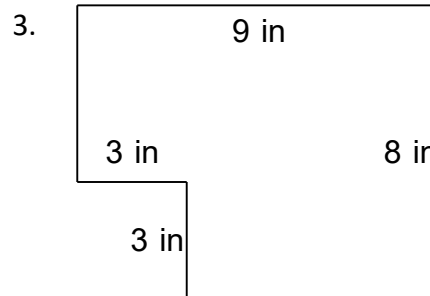

$P = 34 \text{ in}$

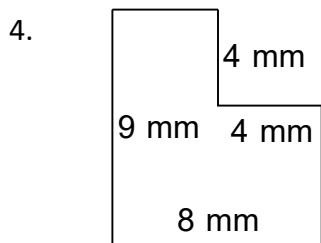

$P = 34 \text{ mm}$

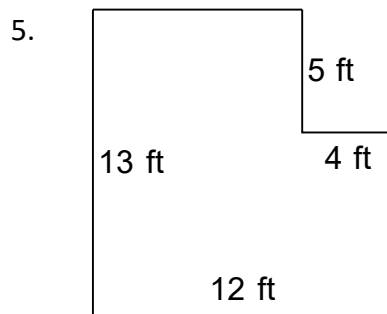

$P = 50 \text{ ft}$

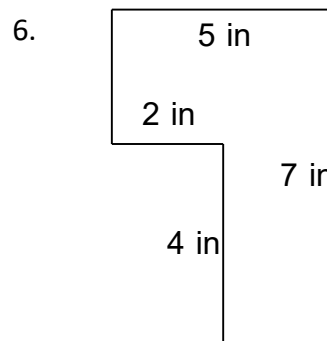

$P = 24 \text{ in}$

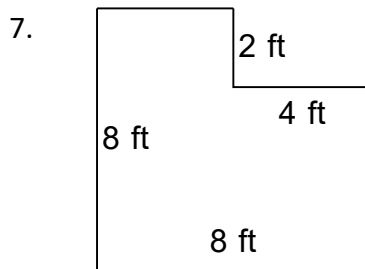

$P = 32 \text{ ft}$

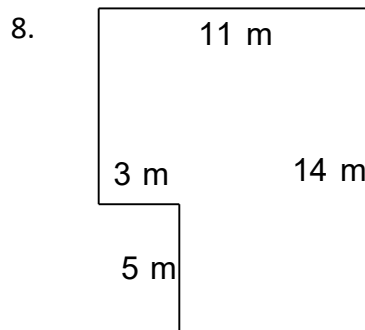

$P = 50 \text{ m}$

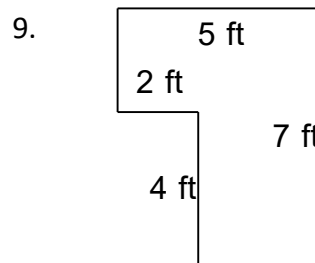

$P = 24 \text{ ft}$

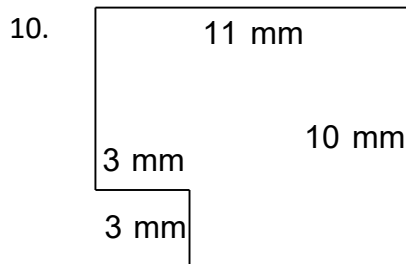

$P = 42 \text{ mm}$